



IPG ALUMINIUM PALLETS

TAYLORMADE PALLETS



71036

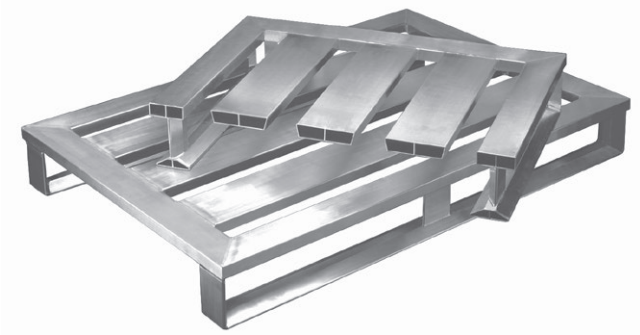

net weight: approx. 14,4 kg

loading capacity: 1.000 kg (surface load)

70601

net weight: approx. 12,0 kg

loading capacity: 600 kg (surface load)

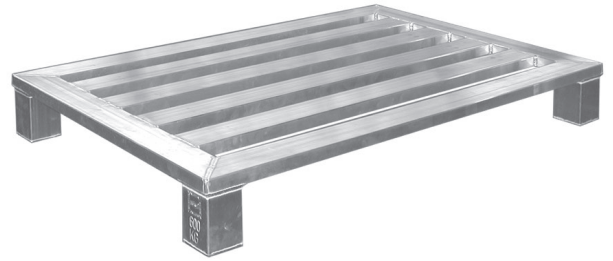

71035



net weight: approx. 13,0 kg

loading capacity: 1.000 kg (surface load)



71057

net weight: approx. 15,2 kg

loading capacity: 1.200 kg (surface load)



71566



net weight: approx. 14,6 kg

loading capacity: 1.500 kg (surface load)



71037

net weight: approx. 16,4 kg

loading capacity: 2.000 kg (surface load)



71042

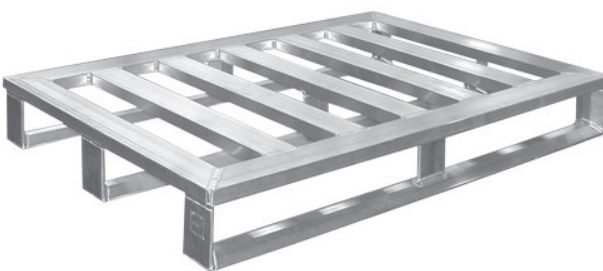

net weight: approx. 15,0 kg

loading capacity: 2.000 kg (surface load)

71570

net weight: approx. 16,8 kg

loading capacity: 2.500 kg (surface load)



72061



net weight: approx. 20,5 kg

loading capacity: 3.000 kg (surface load)

Characteristic: Identical to the European pool pallet- High Loading Capacity!

71644

net weight: approx. 16,4 kg

loading capacity: 1.000 kg (surface load)



Characteristic: Struts made of rectangle profile – low risk of damage, low risk of running over with handcarts!

71974



net weight: approx. 11,5 kg

loading capacity: 1.000 kg (surface load)

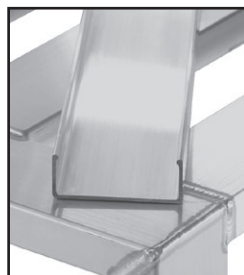

Characteristic: struts made of u-profiles- Low Net Weight

71054



net weight: approx. 17,9 kg
loading capacity: 800 kg (surface load)

71572

net weight: approx. 17,6 kg
loading capacity: 1.500 kg (surface load)



72047



net weight: approx. 18,9 kg
loading capacity: 1.500 kg (surface load)

SPECIAL PALLETS

PALLETS WITH METAL DECK



Standard-Metal-Aluminum

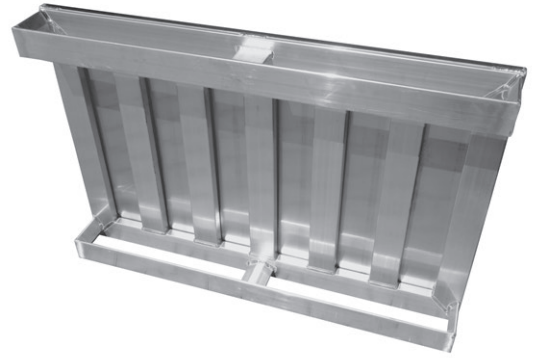

Bottom

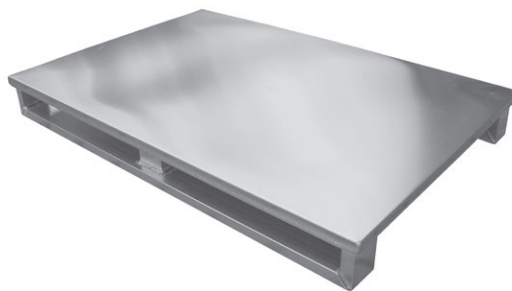

Top



Aluminum-Perforated-Metal

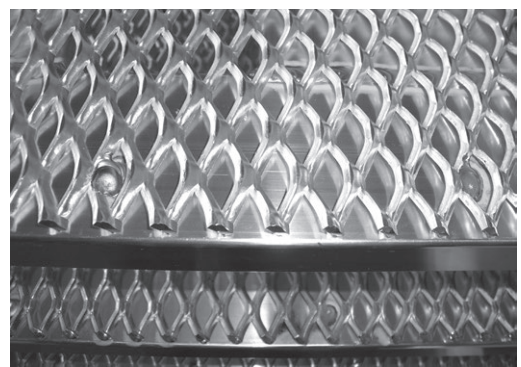

Aluminum-Stretched-Metal

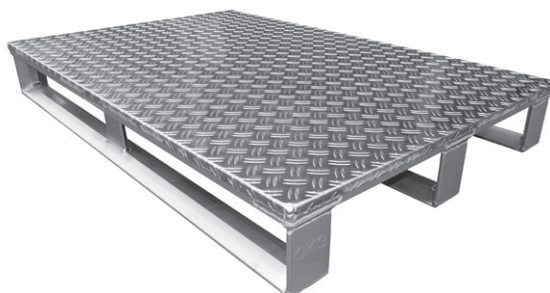

Aluminum-Checker-/Bulb-Plate

The pallet consists of a complete layer of aluminum welded deck.

Characteristic:

The inner nucleus of the sandwich can consist from aluminum profiles or PP-honeycombplates.

This nucleus is fixed between two aluminum metal plates and welded. This sandwichsystem allows easy cleaning of the pallets because there are no open spaces in the construction.

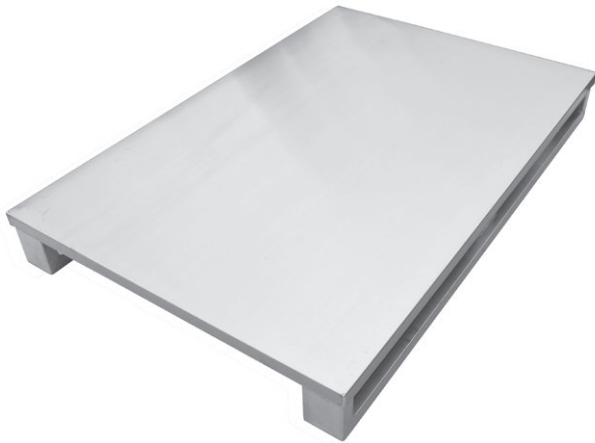

Top - Sandwich



Bottom - Sandwich

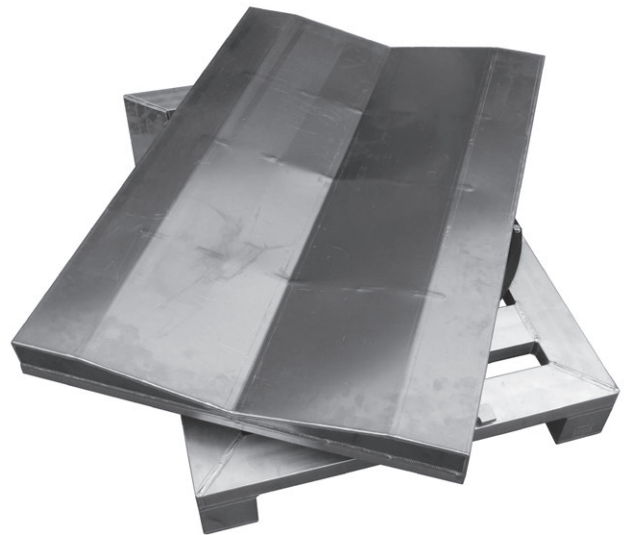
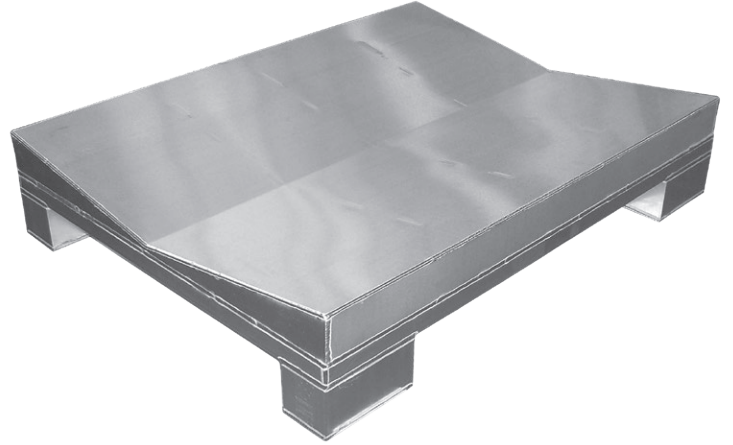

Hollowpallet

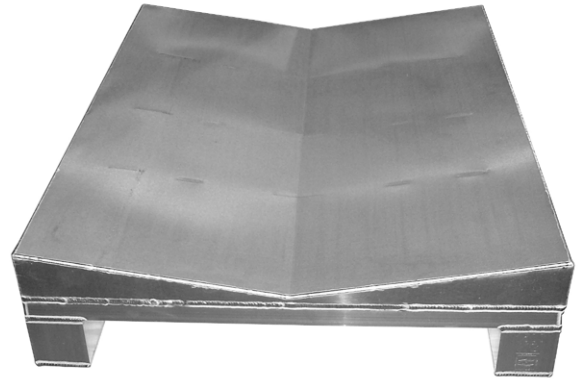
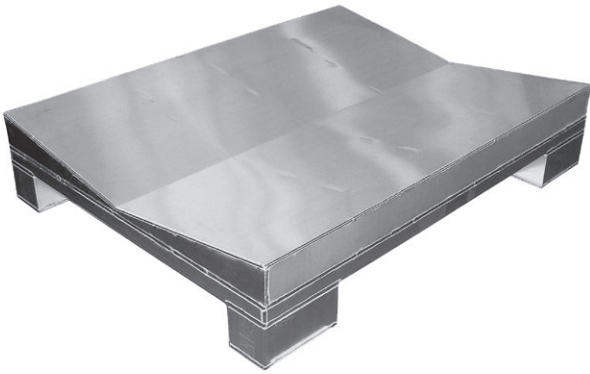

Hollowpallet with revolving possibility

360° swiveling (to click each 90° step)

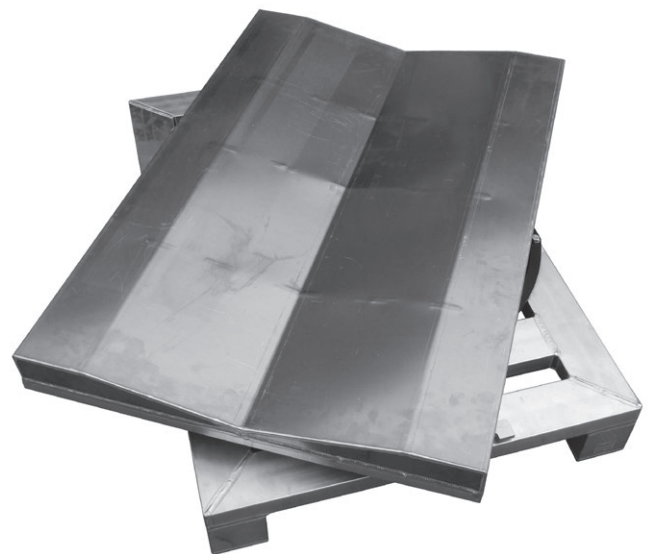

Safe Lengthwise Storage

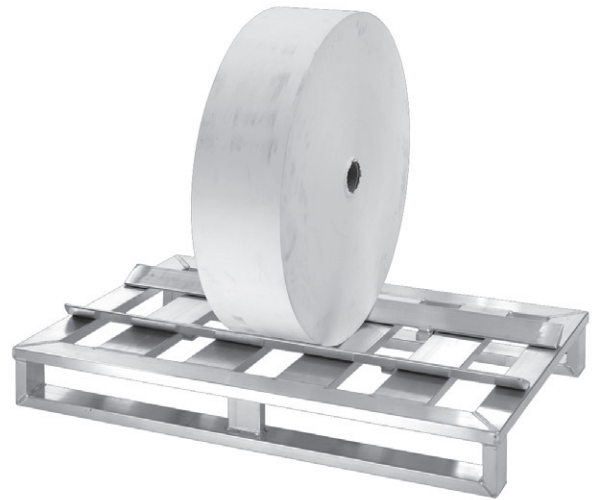
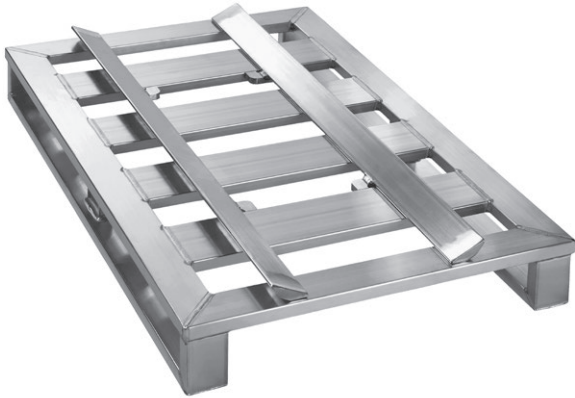

Safe Crosswise Storage

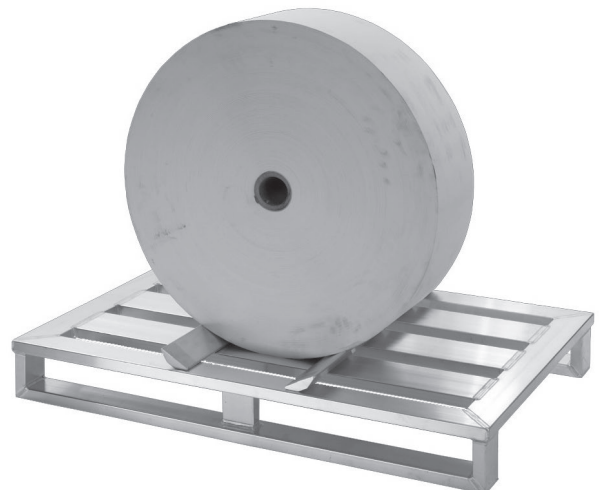

Adaptable to each role diameter:



Operating Instructions (patented)

Step 1



Insert safetywedge diagonal into the pallet deck

Step 2

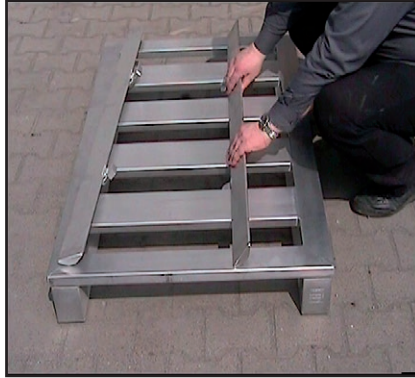

Aline safetywedge parallel to the pallet deck

Step 3



Press down to fix the safetywedges

Step 4

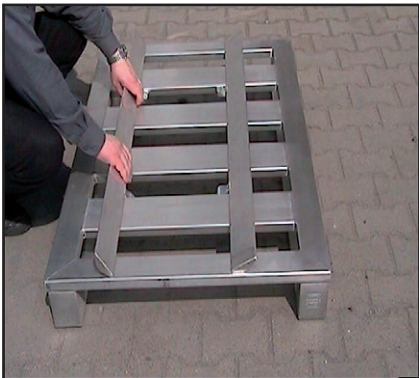

Same procedure step 1 to step 3 for opposite side

Step 5



To take off or to move the wedges please fold up the wedges (remove them)- now the wedges are flexible for a new width or removable

Step 6



Rigid (welded)

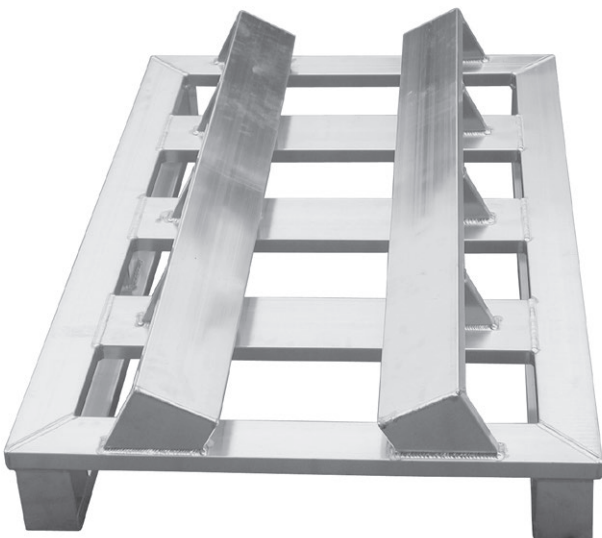
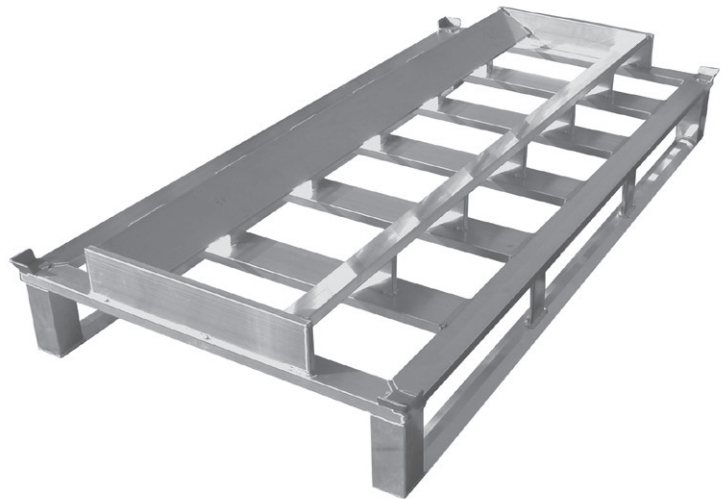
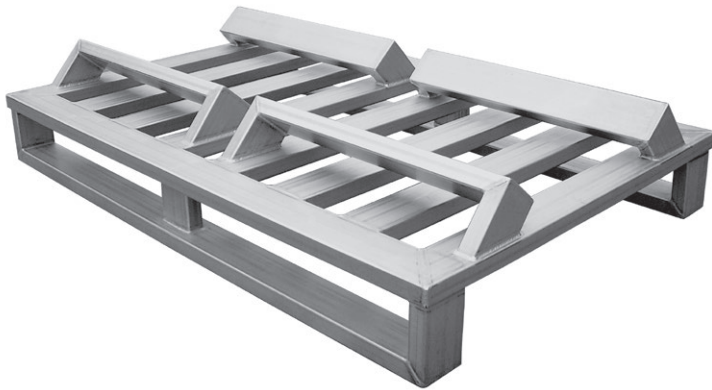
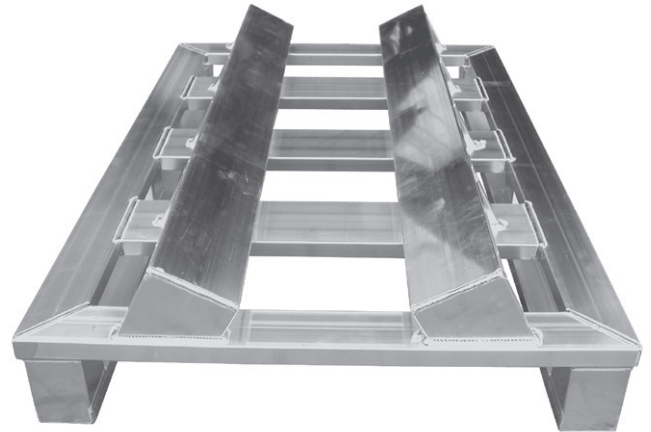

Examples: flexible securing in diameter AND width

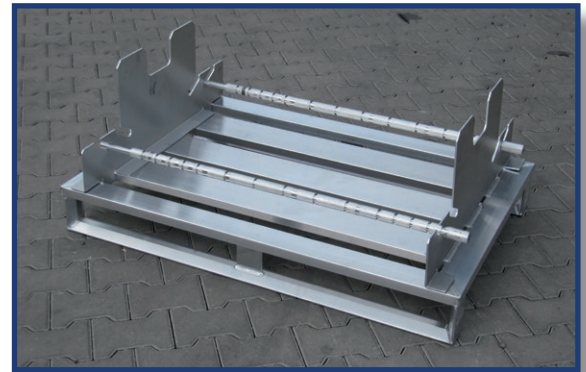
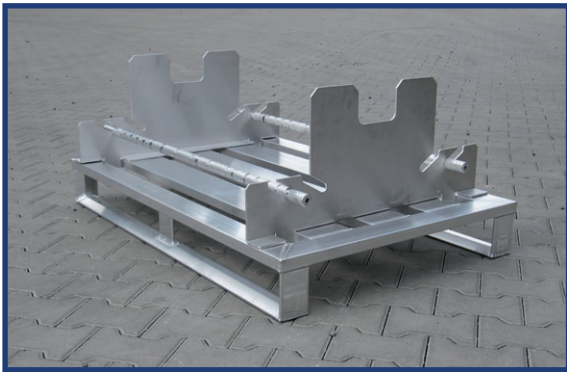
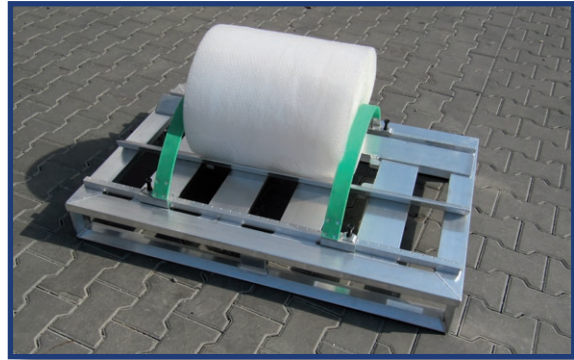
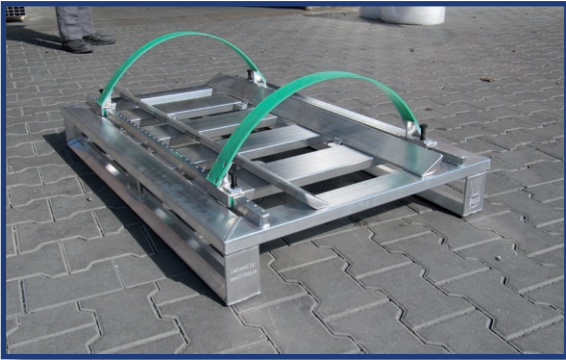

For goods with fix diameter,
with different widths and tiltsafety



Additional to our standards for product quality and economic handling we focus our doing on natural resources and on sustainable production processes.

Our company supports sustainable thinking and handling.

Environmental protection means:

- Following the legal rules
- Avoiding environmental pollution
- Effective usage of resources
- Focussing on sustainable handling for each employee



Our environmental targets are equal to our qualitative and economic targets.

Our products consist of 100% recyclable material.

The recycling process of aluminum only needs 10% of energy compared to the original production process of aluminum as raw material.

During our production process all waste pieces are recycled 100%.

SUSTAINABILITY/ REPAIRSERVICE

You send broken aluminum pallets and we repair if possible.

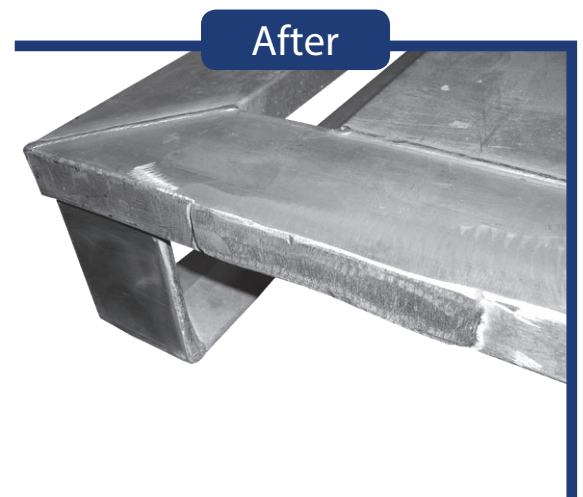
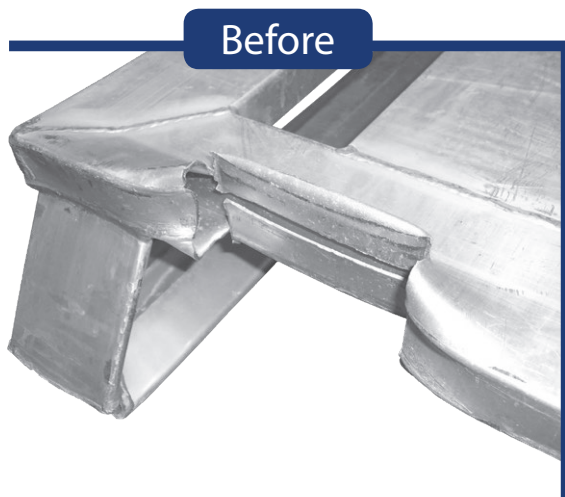

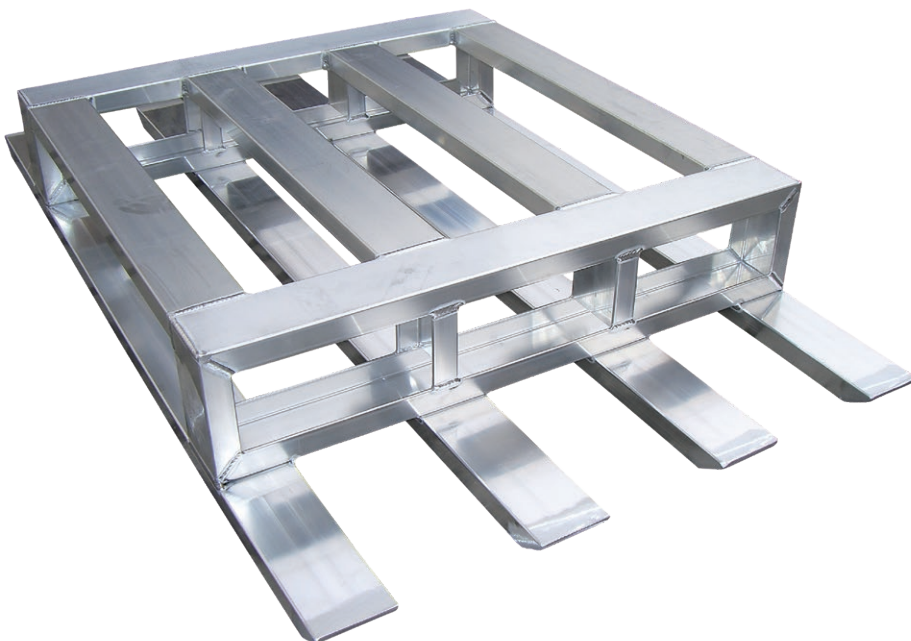
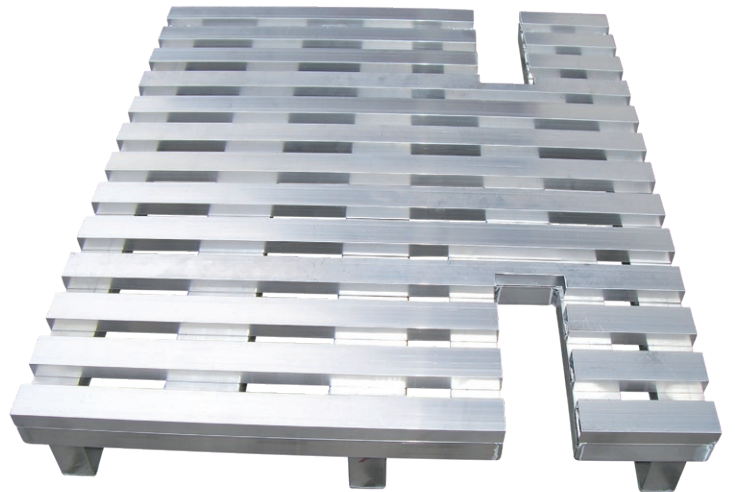

in a lying position



to be placed upside



optional with safety rack

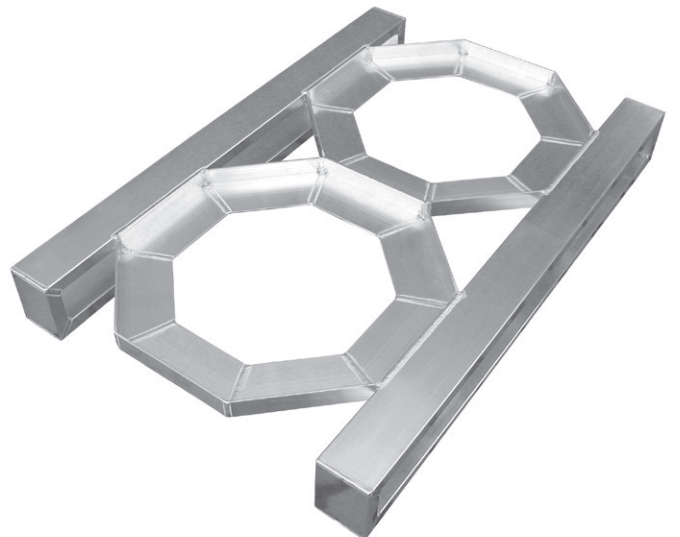

Safety racks for single barrels

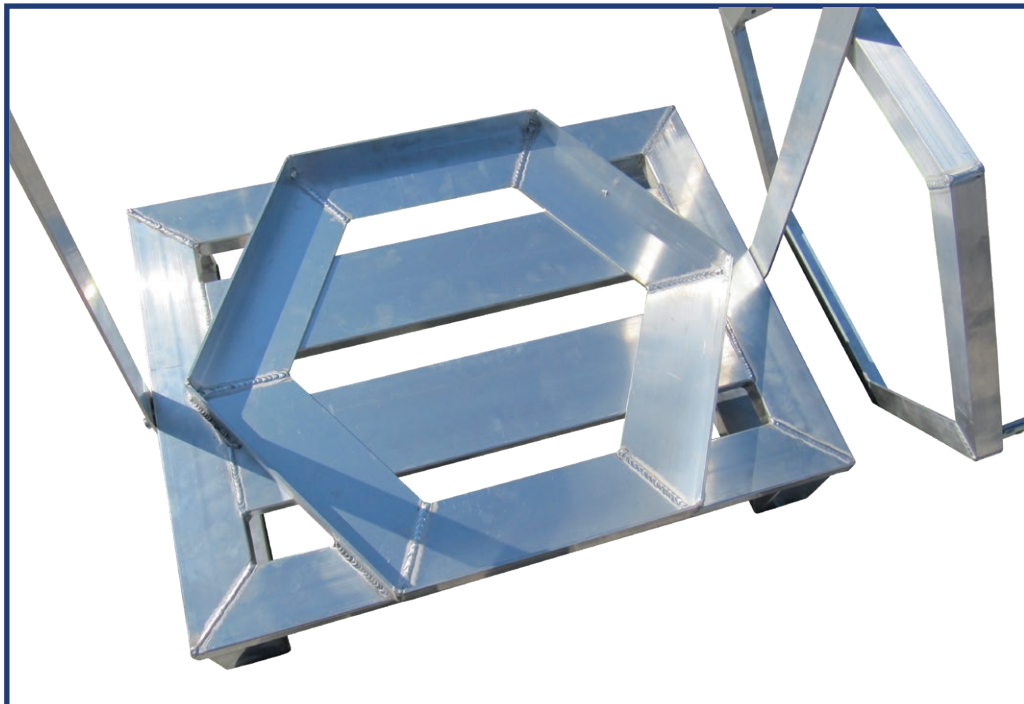
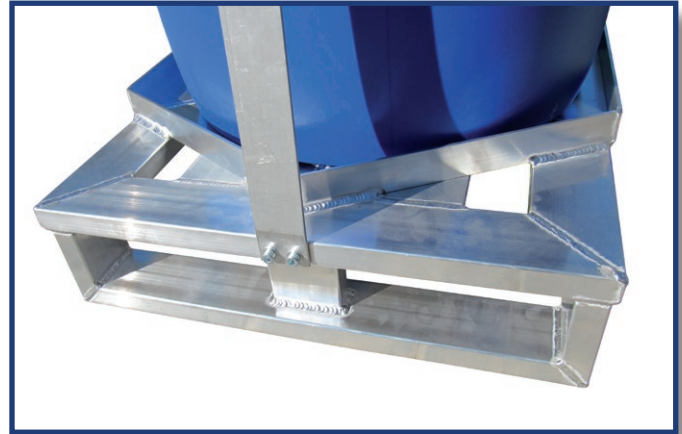

for pallets in european size and industrial format

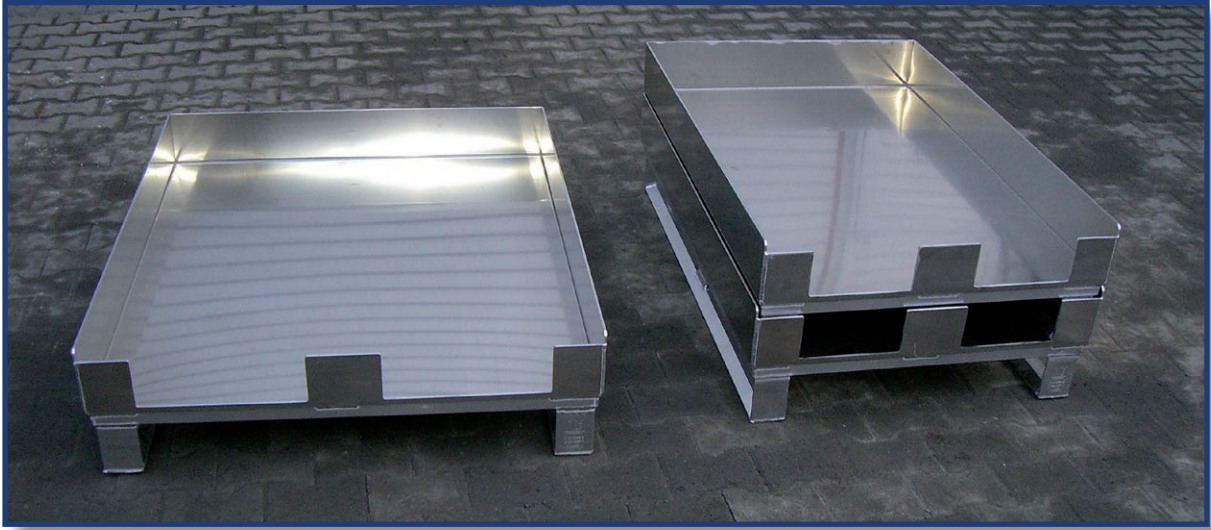

Examples

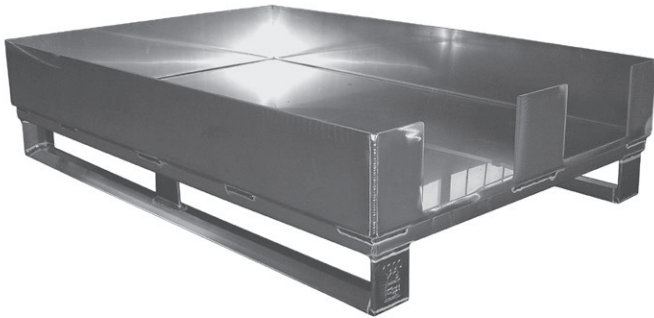

Special Construction – Trapeze Tray

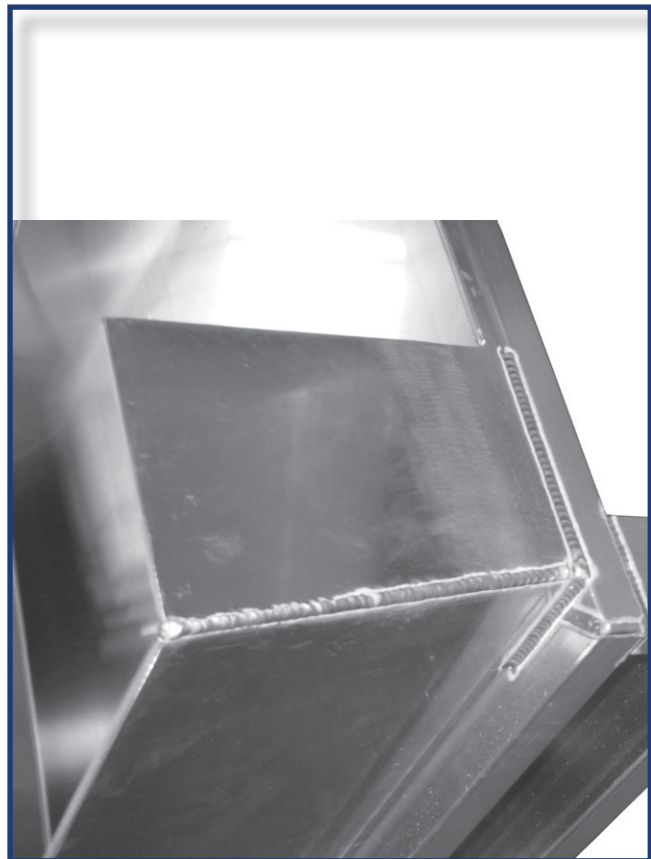
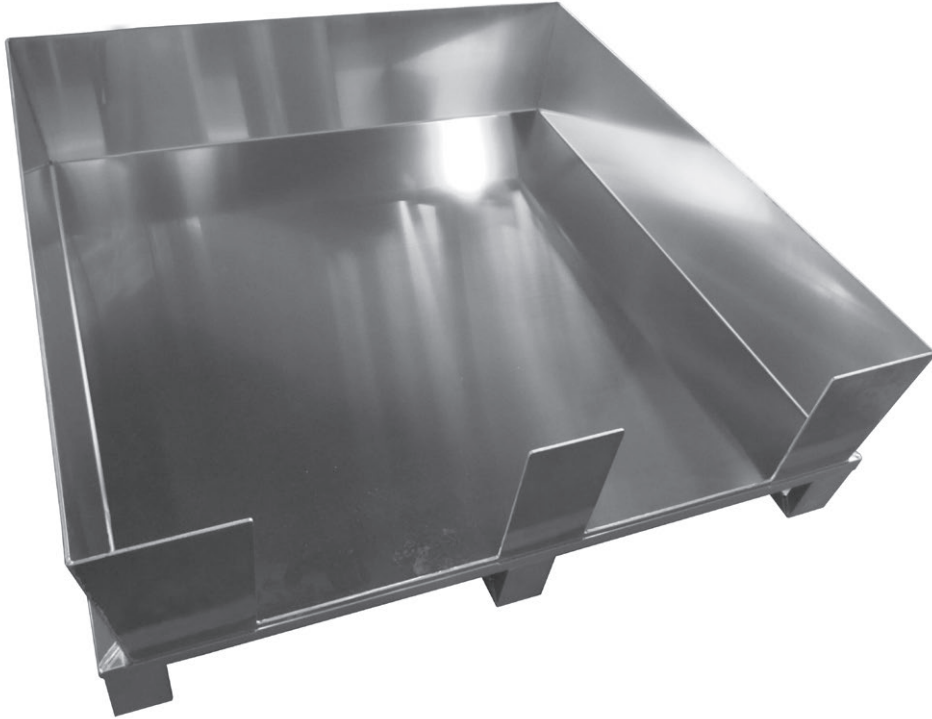

Aluminum-Pipeprofile with integrated tray

20 mm Hight

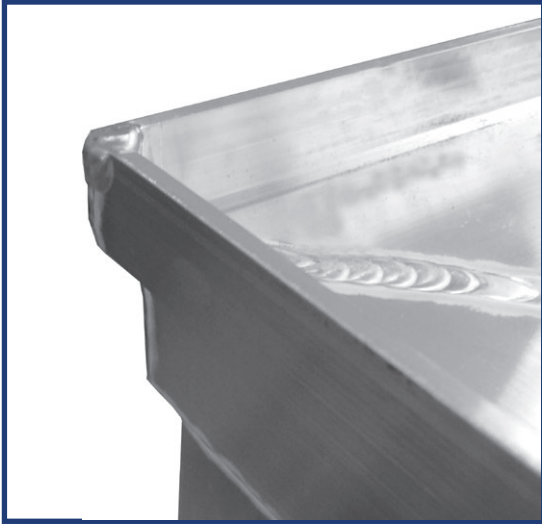

10 mm Hight

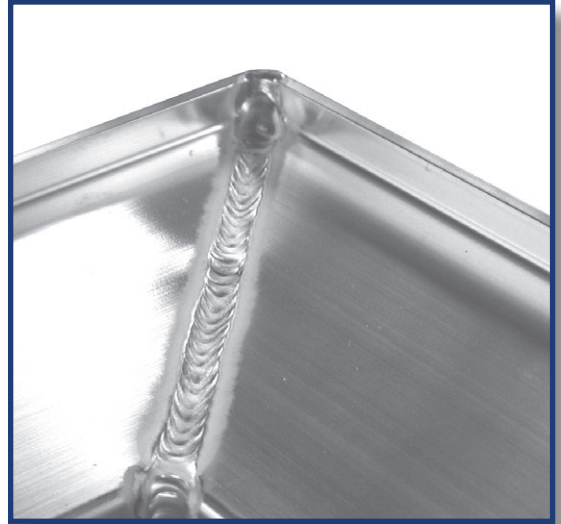

Examples



Examples

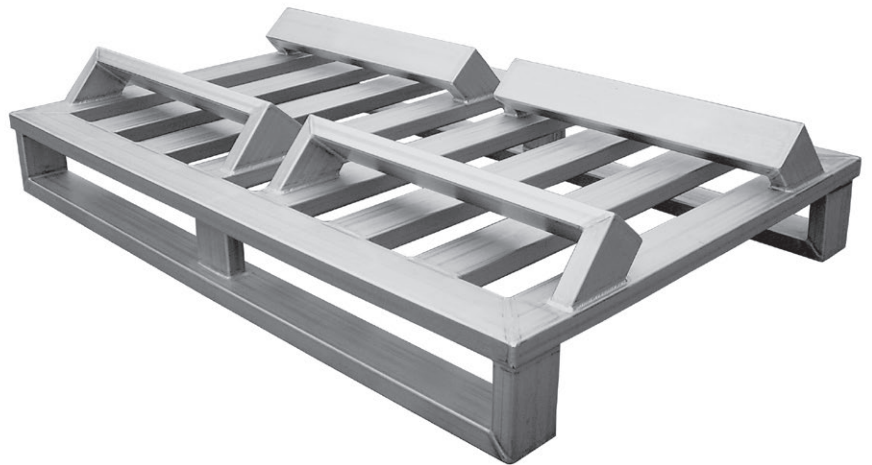

SPECIAL PALLETS

With PE Struts/ PE Gliders

(for protection of sensitive floors)



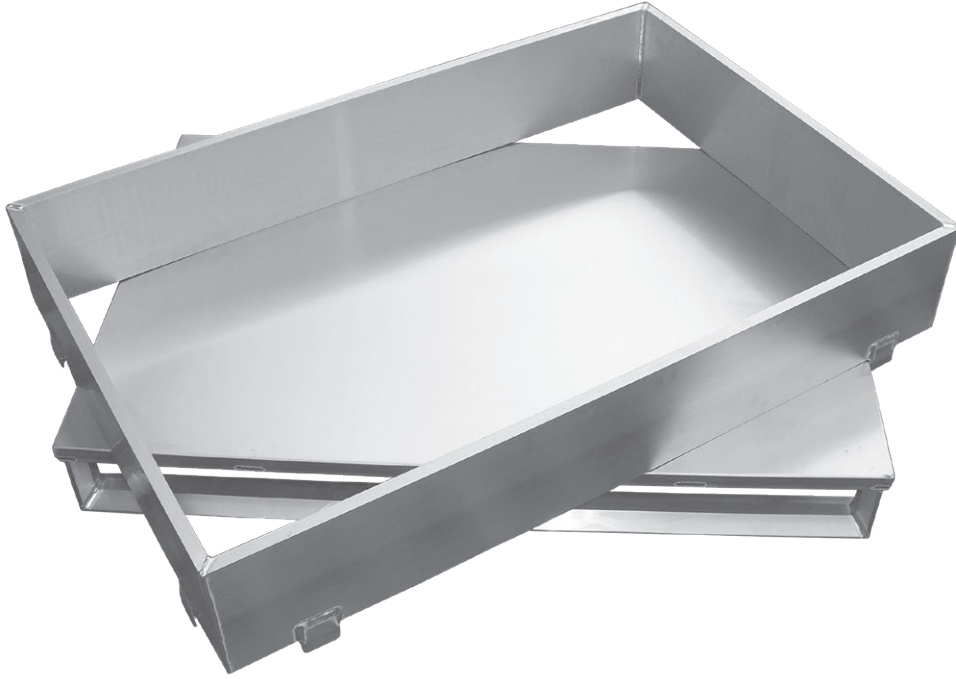

PALLET TOP

Top Frame foldable



PALLET TOP

Top Frame foldable

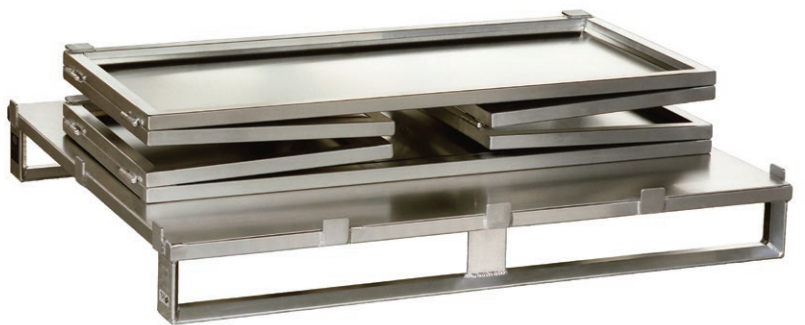





HEADOFFICE NORWAY

IPG Intelligent Packaging Group AS
Hensmoveien 46 • 3516 Hønefoss • Norway
Cell Phone: +47 960 49 556
info@ip-group.no • www.ip-group.no

HEADOFFICE SWEDEN

IPG Intelligent Packaging Group AB
Västrevångleden 2 • 302 41 Halmstad • Sweden
Tel: +46 35 102480
info@ip-group.com • www.ip-group.com



