

IPG FISHING CONCEPT

A PROFITABLE FISH CONCEPT



IPG FISHING CONCEPT
SMART PRODUCTS FOR YOUR FISH LOGISTICS



CONTENTS LOGISTICS



Fish and meat industry

Insulated Containers for Ice	Page 3
Insulated Containers Type Pur standard	Page 3
Insulated Containers PE HEavy Duty	Page 4
Accessories for Insulated Containers	Page 4

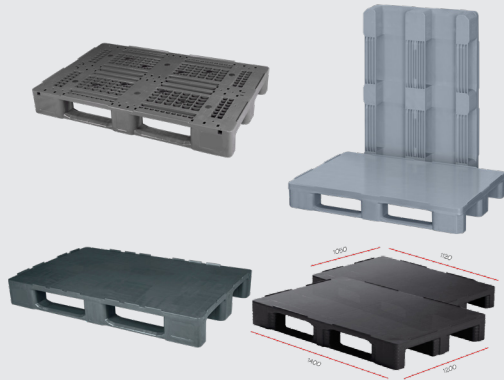

Pallet for Fish and meat industry

Distribution Pallet Open Deck	Page 5
Hygienic Pallet Closed Deck	Page 5
Closed Pallet Heavy Duty	Page 6
Special Pallets in Special Dimensions	Page 6



Pallet Containers

Hygienic Pallet Closed Deck	Page 7
-----------------------------	--------



Fish and meat industry

Bounded Pallets	Page 9
Freeze Spacers	Page 10
Floor Grates Clean Floor	Page 10
Fish Boxes	Page 11
Rounded Buckets	Page 11



IPG Fish Cage

IPG Fish Cage Special for stock fish	Page 12
--------------------------------------	---------



Tipper

Tipper for Insulated Containers and Boxes	Page 13
---	---------

FISH AND MEAT INDUSTRY

Insulated Containers for Ice

Descriptions:

Insulated containers with lids are made with PUR insulation. They are hygienic and easy to clean. The construction is solid. Ensures freshness of the batch for a long time. The containers are stackable on each other. May have drain holes protected by plugs. The lids are tight and secured with rubber grips. Made of high quality UV stabilized resin that ensures their long usage in outdoor conditions.



Article No.	Dimensions (mm)	Type / Capacity (L)
FI-ICE-20	410 x 290 x 320	20
FI-ICE-35	542 x 452 x 239	35
FI-ICE-50	645 x 405 x 420	50
FI-ICE-70	750 x 530 x 430	70
FI-ICE-100	750 x 560 x 520	110
FI-ICE-150	840 x 575 x 745	220
FI-ICE-250	1015 x 700 x 758	220

Insulated Containers Type Pur Standard

Descriptions:

High insulation pallet containers are suitable where high insulation is needed e.g. when no cooling equipment is available or outdoor conditions are vary. Our high-insulation pallet containers will keep the content at a stable temperature or when needed, at a temperature as low as approximately - 18°C.



Article No.	Dimensions (mm)	Type	Capacity (L)
IP-PS-310	915 x 715 x 710	310	330
IP-PS-460	1230 x 1030 x 580	460	480
IP-PS-660	1230 x 1030 x 750	660	670
IP-PS-660 NN	1235 x 1035 x 750	660 NW	670
IP-PS-R1000	1470 x 1180 x 890	1000	1100



FISH AND MEAT INDUSTRY

Insulated Containers PE Heavy Duty



Descriptions:

Heavy-duty pallet containers are widely recognised as the strongest insulated plastic pallet containers on the market. They are suitable when there is a high demand for strength and carrying capacity, e.g. for heavy and / or long, steady loads.

Article No.	Dimensions (mm)	Type / Capacity (L)	Colour
IP-PS-600HD	1200 x 1000 x 750	600/630 L	Beige
IP-PS-660HD	1200 x 1030 x 760	600/630 L	Beige / Blue

Insulated Cooler Boxes



Descriptions:

Solid construction makes Cooler Boxes durable especially during transportation. Available capacities: 25, 45 & 65 litres. Destined for direct contact with food. Usually used as mobile cooling containers for travelling purpose. Also used as medical transport unit for e.g. medicines, vaccines, etc.

Article No.	Dimensions (mm)	Inner dimension
IP-CB-25	560 x 395 x 370	410 x 268 x 258
IP-CB-45	720 x 435 x 420	566 x 293 x 305
IP-CB-65	820 x 450 x 460	677 x 312 x 430

Accessories for Insulated Containers

Lids



All pallet boxes have PUR insulated lids. Mount with rubber tensioners that are UV resistant. Their use does not make them completely watertight. It is possible to stack containers with lids.

Compation Lock



They are used to store the product under the Surface of liquid in the container, for example during cooking or pickling. They are available for 400, 600, 700, 460 and 660 type containers.

Rubber Strap



Strong rubber strap are used for closing containers with lids. UV resistant

Key for Drain Plugs



FISH AND MEAT INDUSTRY

Distribution Pallet

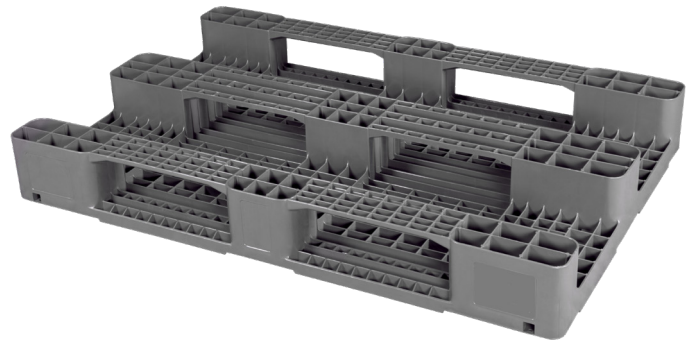

The distribution pallet is a durable load carrier with an attractive price/performance ratio. Ideally suited for use as distribution pallet in the entire non-food area.

Article No.	Dimensions (mm)	Colour	Safety rim	Pallet unit (pcs)
IP-DP-1208	1200 x 800 x 150	Black	Yes	20
IP-SP-1208	1200 x 800 x 150	Black / Grey	No	20
IP-DP-1210	1200 x 1000 x 150	Black	Yes	20
IP-SP-1210	1200 x 1000 x 150	Black / Grey	No	20

Hygienic Pallets for Cleanroom Perforated

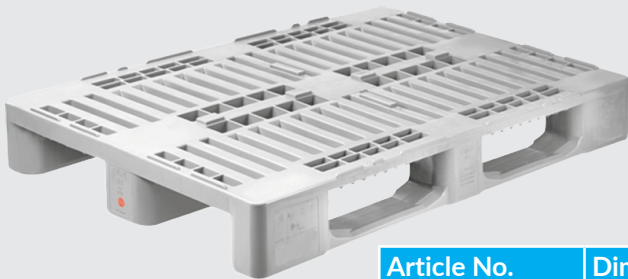

Hygienic pallet H1 1200x800 mm is the most commonly used in the food industry. It is resistant to extreme temperature modulation and easy to clean.

Article No.	Dimensions (mm)	Colour	Construction	Pallet unit (pcs)
IP-H1-1208	1200 x 800 x 160	Grey	3 skids closed	20

Hygienic Pallets for Cleanroom Closed

Plastic hygienic pallets are made of single piece of new material in the form of monolith allowed to transport food. They are resistant to low and high temperature and easy to clean. European standard for export pallets with food grade certificate.

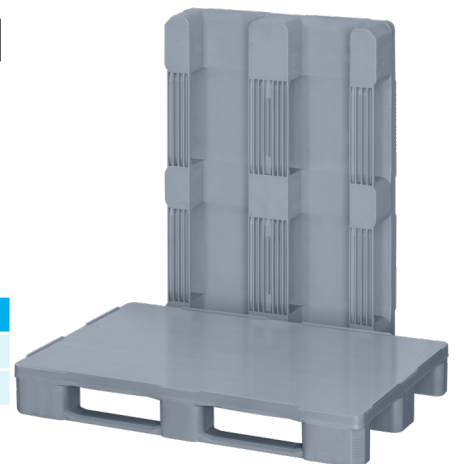

Article No.	Dimensions (mm)	Colour	Construction	Pallet unit (pcs)
IP-HC-1208	1200 x 800 x 160	White / Grey	3 skids	20
IP-HC-1210	1200 x 1000 x 160	White / Grey	3 skids	20

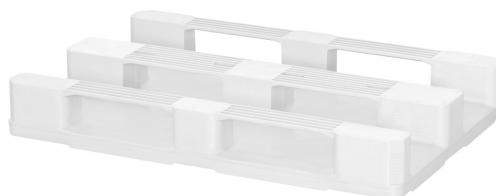

FISH AND MEAT INDUSTRY

Closed Pallets Heavy Duty

A great solution when heavy cargo is loaded. Made from high quality recycled HDPE and easy to keep clean.



Article No.	Dimensions (mm)	Colour	Construction	Pellet unit (pcs)
IP-HC-1208	1200 x 800 x 160	White / Grey	3 skids	20
IP-HC-1210	1200 x 1000 x 160	White / Grey	3 skids	20

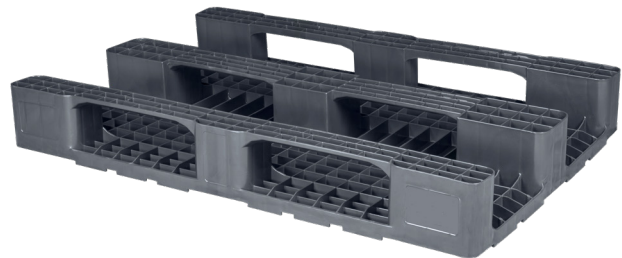
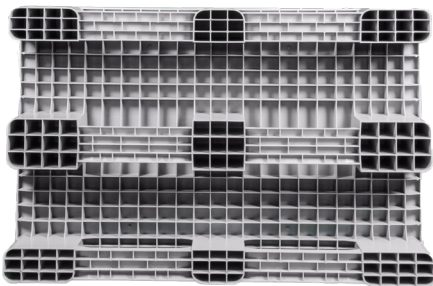

Pallet in Special Dimension

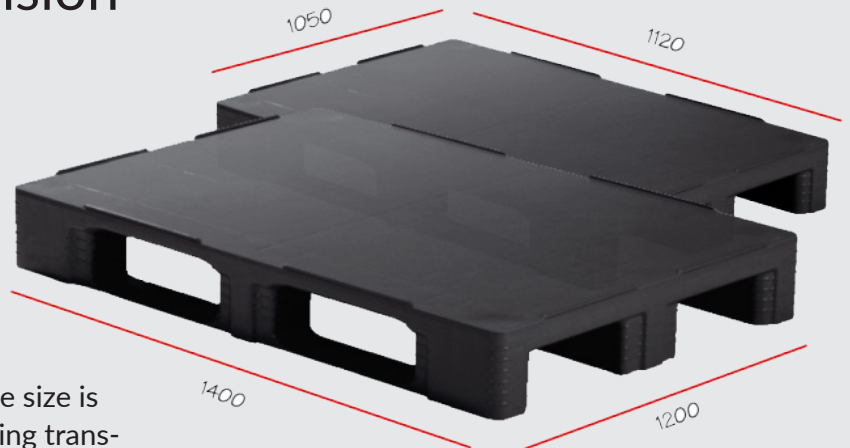

Do you need to send goods on pallets but the size is unusual? Worried about damaged goods during transport?

From today this problem doesn't exist!

Contact me: geir.persen@ip-group.no

I will help you to create a pallet of a customized dimensions pallet.

FISH AND MEAT INDUSTRY

Pallet Container Closed

Single walled plastic containers are made of solid prime and resistant resin. Smooth internal and external walls are easy to clean. Standard dimensions (Euro 1.200 x 800 mm or ISO 1.200 x 1.000mm) they are guarantee smooth working processes in storage and transport.

- Formats ISO, EURO and dimensions on request
- Approved with direct contact with food
- They are available on 4 feet, on 3 skids or on wheels
- Skids and removable feet
- Optionally lid and drain valves
- Stacking ability
- Up to 4 t static load
- Up to 450 kgs dynamic load
- Standard colour: light grey, other on request
- Weather, UV and most acids and alkalie resistant
- Smooth inner walls allow to maintain the hygienic regime.



Article No.	Dimensions (mm)	Colour	Construction
PB-CLF1208	1200 x 800 x 800	Grey	4 feet
PB-CLS1208	1200 x 800 x 800	Grey	2 skids
PB-CLW1208	1200 x 800 x 900	Grey	4 wheels
PB-CLF1210	1200 x 1000 x 745	Grey	4/6/7 feet
PB-CLS1210	1200 x 1000 x 745	Grey	3 skids
PB-CLW1210	1200 x 1000 x 900	Grey	4 wheels
PB-CLF1210	1200 x 1000 x 580	Grey	4 feet
PB-CLS1210	1200 x 1000 x 580	Grey	3 skids
PB-CLF1210	1200 x 1000 x 580	Grey	4 feet



FISH AND MEAT INDUSTRY

Pallet Container Perforated

The maximum usage of the capacity of Big-Boxes is time and money saving when it comes to transport, handling and storage costs.

- Breathable, perforated sides and walls
- Low weight
- Easy to clean
- Stackable

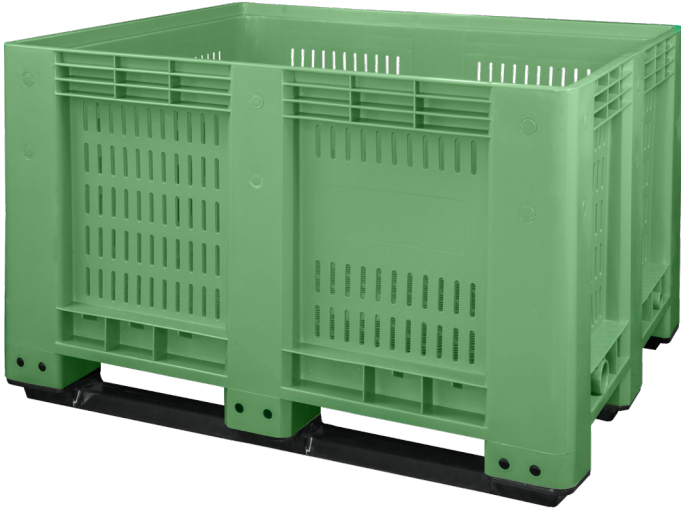

Article No.	Dimensions (mm)	Colour	Construction
PB-PFF1210	1200 x 1000 x 580	Grey / Green	4 feet
PB-PFF1210	1200 x 1000 x 745	Grey / Green	4/6/7 feet
PB-PFS1210	1200 x 1000 x 745	Grey / Green	4 skids
PB-PFF1210	1200 x 1000 x 900	Grey / Green	4 feet

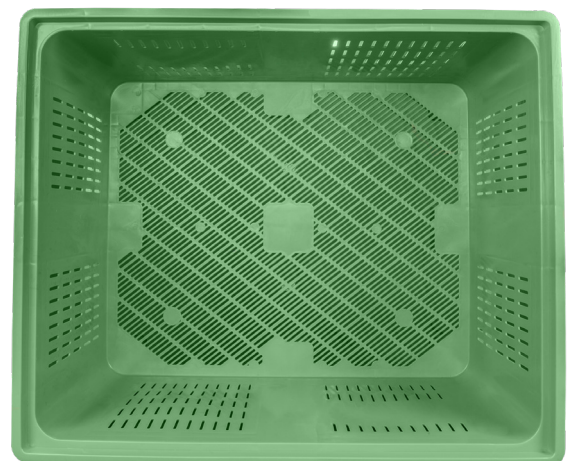
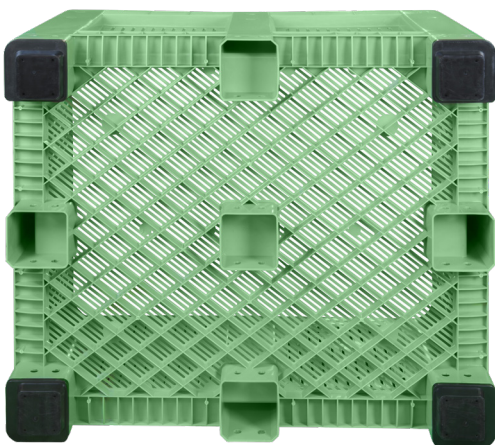
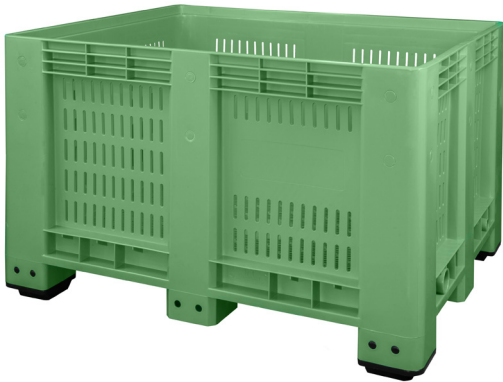

FISH AND MEAT INDUSTRY

Pallet Container Foldable



IP-Group foldable pallet boxes with perforated sides and bottom are specially designed for the storage and transportation of various goods. When unloaded, walls can be folded to the inside that makes it much usable, space saving solution and allows to reduce transportation costs.

- excellent solution for storing and transportation of the goods
- perforated, foldable sides,
- available in perforated and closed version
- matching flap door on request
- optimized volume

Article No.	Dimensions (mm)	Colour	Construction
PB-FCF1210	1200 x 1000 x 800	Grey	4 feet
PB-FCS1210	1200 x 1000 x 800	Grey	2 skids
PB-FCF1210	1200 x 1000 x 800	Green	4 feet
PB-PFF1210	1200 x 1000 x 800	Green	2 skids

Bunded Pallets for Hazardous Materials



Bunded pallets and work floors by IP-Group are a safe solution for containers with hazardous liquids. Made from special resins, they are resistant to chemicals and UV radiation. Used as a protection in case of leaks from barrels filled with hazardous content e.g. oils, pesticides. Durability – made from medium density polyethylene are durable and resistant to solar radiation, weather conditions and mechanic damages. Safety – removable inserts make clearing easier. Its light weight allows to move them with minimal effort. Maximum load capacity is 290 kg. Some of them are accessible by forklift other can be linked by special locks which enables to form of work floors.

Article No.	Dimensions (mm)	Applies
IP-BPH4	1400 x 1400 x 270	for 4 barrels, high
IP-BP-4	1410 x 1410 x 140	for 4 barrels
IP-BPH2	1410 x 760 x 420	for 2 barrels, high
IP-BP-2	1410 x 760 x 140	for 2 barrels
IP-BP-1	770 x 770 x 170	for 1 barrels



FISH AND MEAT INDUSTRY

Freeze Spacers

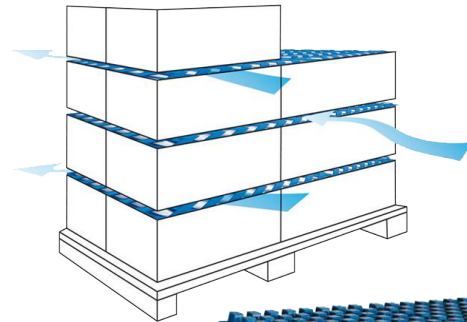

Unique construction, providing maximum air penetration, durability and easy operation. Approved for food contact. Produced in HDPE - resistant to most acids and chemicals. Designed for temperature sensitive applications. Can operate at temperatures from -50 ° C to + 90 ° C. Air circulates rapidly through the distance recesses to ensure faster and more efficient freezing process throughout the entire pallet load. Maximum air penetration during freezing and hardening operations. Locks for freezers are available in two types: 1200 x 800 and 1200x1000mm. Standard colors: blue and black others available upon request only.

Article No.	Dimensions (mm)	Max. Load kg	Colour
IP-FS1208BL	1200 x 800 x 150	3000	Blue
IP-FS1208A	1200 x 800 x 150	3000	Black
IP-FS1210BL	1200 x 1000 x 150	3000	Blue
IP-FS1210BA	1200 x 1000 x 150	3000	Black

Floor Grates Clean Floor

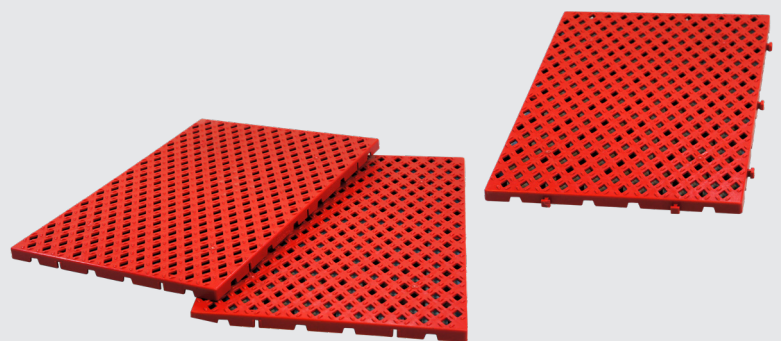
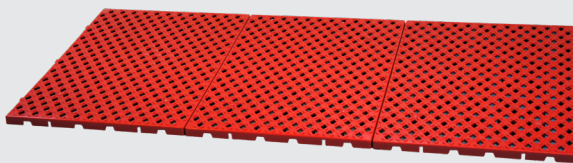

To be installed only on rigid floors, available in LLDPE, these are easy to assemble. Very resistant to acids, corrosion, bases, oils, as well as to extreme temperatures (from -40°C up to +80°C), antibacterial and odourless, sterilizable, are easy to clean, isolate and evacuate water. They may be used in any kind of industry, including chemical or food commodities.

Single unit: 600x400x20mm, or 0,24 m2.

Article No.	Dimensions (mm)	Load capacity	Colour
IP-FG10050	1000 x 500 x 50	60 000 kg/m2	White/grey/brick
IP-FG5025	500 x 500 x 25	97 000 kg/m2	White/grey/brick
IP-FG5050	500 x 500 x 50	60 000 kg/m2	White/grey/brick
IP-FG6040	600 x 400 x 20	50 000 kg/m2	Brick

FISH AND MEAT INDUSTRY

Fish Boxes



Fish crates from IP-Group are destined to fulfill our client's requirements. They are made to endure hard conditions on ships, in processing plants etc. They are also compatible with H-1 pallets. All crates and containers are made per EURO standards. We provide Conformity Declarations whit respect to EU regulations.

Article No.	Dimensions (mm)	Colour	Capacity (L)	Pallet unit (pcs)
IP-FB60	600 x 400 x 180	White	15	100
IP-FB80	800 x 450 x 260	White	50	50
IP-FB10-15L	600 x 400 x 125	Blue	15	100
IP-FB10-20L	600 x 400 x 150	Blue	20	100
IP-FB42	740 x 450 x 182	Blue/green	42	48
IP-FB25-36L	800 x 450 x 190	White	36	50
IP-FB40-60L	800 x 450 x 270	White	60	50
IP-FB50-75L	890 x 560 x 235	White	75	50
IP-FB 850	800 x 400 x 190	White	50	36
IP-FB 45	844 x 514 x 190	White/blue	70	20

Round Buckets

The right choice for storing liquids and bulk materials. Round containers, barrels and buckets have a conical shape and can therefore be stored within each other when empty to save space. Smooth inner walls enable fast and simple cleaning.

Round buckets with two handles:



Article No.	Dimensions (mm)	Capacity (L)
RB-3900	390 x 410	35
RB-3905	diameter 390	Lid
RB-3901	460 x 470	50
RB-3906	diameter 460	Lid
RB-3902	480 x 570	75
RB-3907	diameter 480	Lid
RB-3903	520 x 670	100
RB-3908	diameter 520	Lid

Round buckets without handles:



Article No.	Dimensions (mm)	Capacity (L)
RB-3905-1	670 x 810	200
RB-3909	diameter 670	Lid
RB-3910	760 x 890	300
RB-3911	diameter 760	Lid

Round buckets with a tight lid and clamp:



Article No.	Dimensions (mm)	Capacity (L)
RB-3922-CL	495 x 385	75
RB-3923-CL	520 X 415	100



Trolley for round buckets 75/100L

Article No.	Dimensions (mm)
TR-3925	520 x 415 x 670



FISH AND MEAT INDUSTRY

IPG Fish Cage for Stock Fish

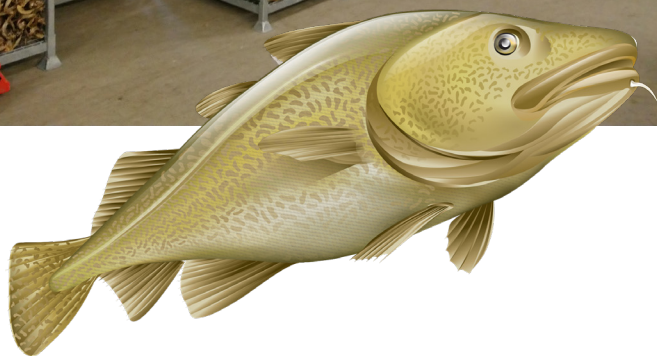

IPG Special Fish Cage for stock fish is hot-galvanized. Each special cage includes 1 pallet, 2 gables and 2 spacers. The Fish Cage can be stacked 2 in height. There is hot galvanized mesh on top of the pallet base.

Article No.	Dimensions (mm)	Height mm
IPG-FC	1200 x 1000	2000

Other dimension on request

FISH AND MEAT INDUSTRY

Tipper for Insulated Boxes and Containers



Tipper for 1200x800 Insulated Boxes and Containers

This model is adapted to emptying transport carriers based on a Euro pallet. These can be 1200x800mm pallets or Gitter-boxes. The IP-BMS800 model is a so-called wide tipper, which means that we place the supported container on the tipper, and more precisely on its profiles. Such a system of positioning an emptied container or box on a tipper allows convenient access by a pallet truck. This model is the most popular and most frequently chosen tipper among the 120x80cm containers offered for handling. This tipper facilitates, facilitates and speeds up unloading of containers at working height.



Article No.	IP-BMS800
Standard dumping height	Approx. 1000 mm
Load	900 kg
Power supply	battery or 400V mains
Material	stainless steel INOX
Tilt angle	from 0 ° to 110 °
Basis	mobile on wheels with stabilizing feet
Lowering indications	Yes, sound
Options	traffic lights, protective mesh on request

FISH AND MEAT INDUSTRY

Tipper for 1200x1000 Insulated Boxes and Containers



The IP-BMS1200 stainless steel tippler is the most universal model of mobile tipplers dedicated to various types of containers. The BMS1200 model is called wide tipper, this means that we place the supported container on the tipper, and more precisely on its profiles. Such a system of positioning an emptied container or box on a tipper allows convenient access by a pallet truck. It is compatible with all pallets available on the market with a base 1200 × 800, 1200 × 1000 and 1200x1200mm. The BMS1200 stainless steel tipper, after extending the discharge tray, can handle insulated containers type 400, 430, 430, 600, 630, 660, 700.

Article No.	IP-BMS1200
Standard dumping height	Approx. 1000 mm
Load	900 kg
Power supply	400V mains of battery
Material	stainless steel INOX
Tilt angle	from 0 ° to 110 °
Actuator	made of stainless steel
Basis	mobile on wheels with stabilizing feet
Lowering indications	Yes, sound
Options	Cover grid, traffic lights

Tipper for for Cymbals 200l



It is a mobile tipper made of stainless steel dedicated to 200-liter dumpers. Its mobile base enables movement between positions in the production hall. The tipper mainly serves cymbals / stuffing carts manufactured in accordance with DIN 9797. The tipper is a simple device that allows you to relieve your employees and improve the efficiency of unloading processes - and thus - to speed up the production time in your company. The tippler is not heavy and it is easy to operate it manually during production by moving between sections in the hall, where its help is needed.

Article No.	IP-BMS-200
Standard dumping height	Approx. 1000 mm
Load	400 kg
Power supply	400V mains of battery
Material	stainless steel INOX
Tilt angle	from 0 ° to 110 °
Basis	mobile on wheels with brakes
Container handle	on the narrower side, along the guides on the long side
Lowering indication	Yes

FISH AND MEAT INDUSTRY

Tipper for IP-MB-O Bowl Model



It is a mobile tipper made of stainless steel. Its mobile base allows movement between positions in the production hall and stabilizing feet keep the machine level during operation. Please provide information on the model used and the manufacturer. The bowl tipper is a simple device that allows you to relieve your employees and improve the efficiency of unloading processes - and thus - to speed up the production time in your company. The tippler is not heavy and it is easy to operate it manually during production by moving between sections in the hall, where its help is needed.

Article No.	IP-MB-O Bowl Model
Standard dumping height	Approx. 1000 mm
Load	900 kg
Power supply	400V mains or battery
Material	stainless steel INOX
Tilt angle	from 0 ° to 110 °
Basis	mobile has wheels with stabilizing feet
Container handle	bowl handle with two pins coming from the tipper
Options	Cover grid, traffic lights, scraper

Tipper for 200 L Drums

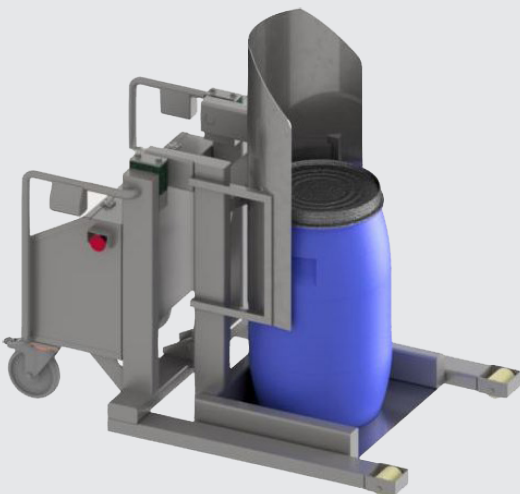

This model has been specially developed for tilting barrels with both loose and liquid products. Hence the special shape of the tray to prevent overflowing of liquid on the sides. The standard tipper works with 200-liter drums, but we are able to adapt it to other barrel capacities. The stainless steel mobile tipper dedicated to barrels has a mobile base that allows movement between stands in the production hall and stabilizing feet keep the machine level during operation.

Article No.	IP-DR200L
Standard dumping height	Approx. 1000 mm
Load	500 kg
Power supply	battery or 400V mains
Material	stainless steel INOX
Tilt angle	from 0 ° to 110 °
Basis	mobile has wheels
Container handle	Circumferentially
Lowering indication	Yes
Options	Protective mesh, traffic lights, stabilizing feet



IPG **FISHING** CONCEPT

WWW.IP-GROUP.COM

